

Diesel Engine Safety Solutions

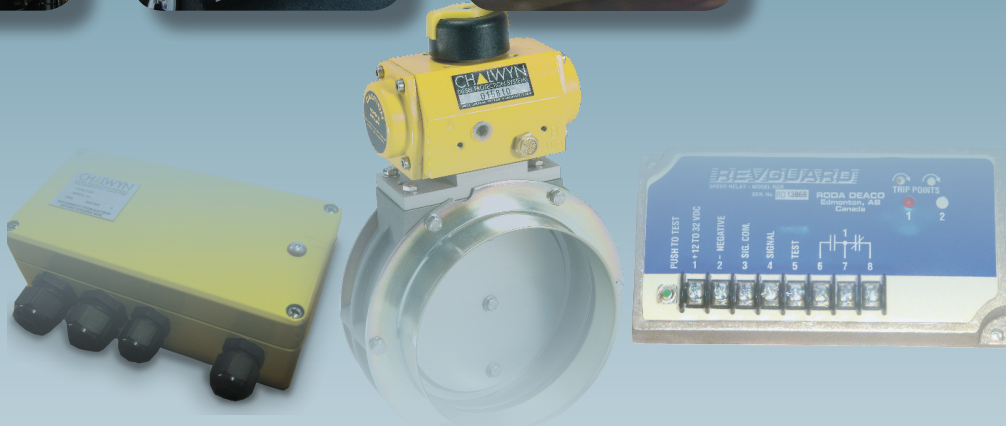

System Selection Guide

Contents

Diesel Engine Overspeed Safety Solutions	2
Diesel Engines: A potential source of ignition	3
Automatic Electric Overspeed Detection Shutdown System	4
Automatic Electric to Pneumatic Overspeed Detection Shutdown System	5
Manual Engine Overspeed Shutdown Systems	6-7
Product Overview	8-9
Automatic Electric System Wiring Diagram	10
Automatic Electric to Pneumatic System Wiring Diagram	11
Contact Information	Back cover

Diesel Engine Overspeed Safety Solutions

Chalwyn has been providing diesel engine overspeed air intake shutoff valves for over 35 years. Chalwyn offers a wide selection of sizes and actuation methods to meet the installation requirements of the hundreds of different diesel engine applications in use today.

Chalwyn has a broad array of fully automatic shutoff systems and manual shutoff systems. Common operating methods include electric, pneumatic, electric/pneumatic, mechanical, or combinations of these mechanisms.

The following pages provide an overview of the most common types of systems used in applications today. The overview includes a description of the solution, a diagram of the components and includes the functional highlights of the components used in each solution. These overviews will provide the information required to help you determine the best type of solution for your application.

For additional application advice please contact our Vehicle Installation Specialist at steve.gale@amot.com



PVX-501 on MAN truck



MPX-500 on Actros truck



SVX-380 on Cummins C.8.3 firetruck



RGR-1S Speed Switch

Diesel Engines: A potential source of ignition

Diesel engine speed is governed by controlling the amount of fuel fed to the engine through its fuel system and internal speed governor. If a flammable material is drawn into the air intake system of a diesel engine it acts as an additional uncontrolled fuel supply. This additional fuel source can cause the diesel engine to accelerate or overspeed out of control. This condition is referred to as diesel engine runaway. The result of a diesel engine runaway can range from engine damage to a catastrophic explosion.

Operating the normal shutdown control will only turn off the engine's diesel fuel source. Once the external flammable gas or vapor is being drawn into the engine intake it may not be possible to stop the engine using the normal engine shutdown. The most effective way of shutting down a runaway diesel engine is with an automatic air intake shutoff valve. An air intake shutoff valve completely blocks the engine air intake pipe, cutting off both the external fuel source and the air required to keep the engine running.

Below are a few industries that operate diesel engines in areas where combustible gas, vapors, or dust can exist:

- Oil & Gas
- Petrochemical
- Mining
- Marine
- Airports
- Power Generation
- Transportation
- Fire Control
- Distilling
- Agriculture

Chalwyn has supplied Diesel Engine Overspeed Safety Shutdown solutions for hundreds of applications. A few example applications are listed below:

- Drilling rigs (onshore & offshore)
- Drilling support equipment
- Well servicing equipment
- Refinery support equipment
- Bulk haulers and road tankers
- Underground mining equipment
- Construction equipment
- Fork lift trucks
- Generator sets
- Air compressors
- Emergency response vehicles
- Aircraft refuelling tankers
- Welding sets
- Work boats and barges
- Hydraulic power packs
- Light towers
- Water pumps
- 'Frac' (hydraulic fracturing) trucks
- Vacuum trucks
- Cranes



Automatic Electric Overspeed Detection Shutdown System

The automatic electric overspeed protection shutdown system is designed to continuously monitor diesel engine RPM to immediately shutdown the engine in the event of an overspeed condition.

The RevGuard Speed Switch monitors engine RPM using either a flywheel mounted magnetic pickup or a signal from the engine alternator. It will immediately transmit a signal to trigger

the shutdown of the Air Intake Shutoff Valve when the engine RPM exceeds a preset limit.

The system also includes a Manual Override Toggle Switch that can be used to trigger a manual emergency closure of the Air Intake Shutoff Valve, or for checking the operation of the intake shut off valve.

Automatic RPM Overspeed Detection Shutdown System with Manual Override

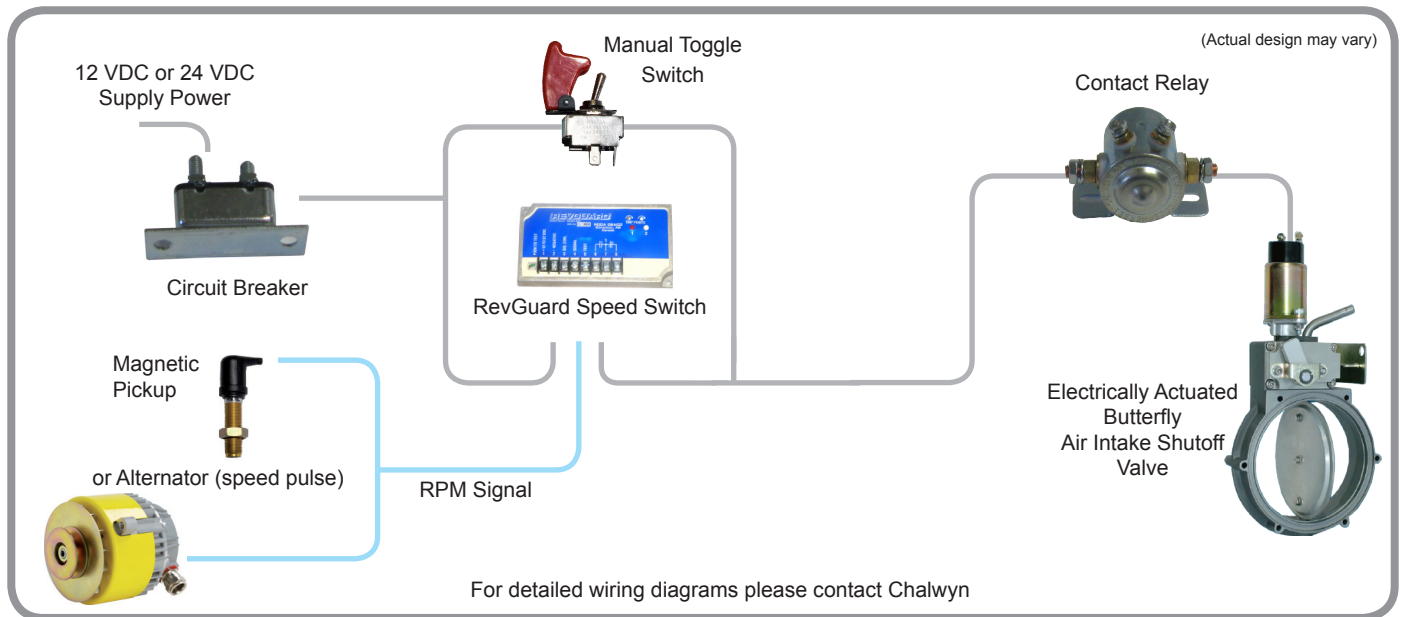

Butterfly Intake Shutoff Valve

Used to seal off intake air to a diesel engine for emergency shutdown

- Sizes range from 1 1/2" to 8"
- Electric versions in 12 or 24 VDC with manual reset
- Temperatures from -40°F to +300°F (-40°C to 150°C)
- Position indicator switch available

RevGuard Speed Switch

Monitors engine RPM to shut down a runaway engine at a preset limit

- Accepts either low or high frequency input
- Operates on 12 or 24 VDC systems
- LED trip indicator
- Built-in 2/3 of RPM test button to simulate overspeed

Magnetic Pickup RPM Sensor

Sensor measures engine flywheel RPM and sends signal to the RevGuard Speed Switch

- Choice of thread sizes
- Installs in existing threaded port
- Unaffected by dirt or foreign materials collecting at sensor tip

Contact Relay

Carries momentary high current to electric valve during operation

Circuit Breaker

Protects system from over current

Automatic Electric to Pneumatic Overspeed Detection Shutdown System

The automatic electric to pneumatic overspeed detection shutdown system is designed to continuously monitor diesel engine RPM to immediately shutdown the engine in the event of an overspeed condition.

The RevGuard Speed Switch monitors engine RPM through either a flywheel mounted magnetic pickup or a signal from the engine alternator. The RevGuard Speed Switch will immedi-

ately activate the 3-way pneumatic solenoid when the engine RPM exceeds a preset limit, which pressurizes the Air Intake Shutoff Valve to close.

The system also includes a manual override toggle switch that can be used to manually close the Air Intake Shutoff Valve to check and demonstrate the operation of the air pressure system.

Automatic Electric to Pneumatic RPM Overspeed Detection Shutdown System with Manual Override

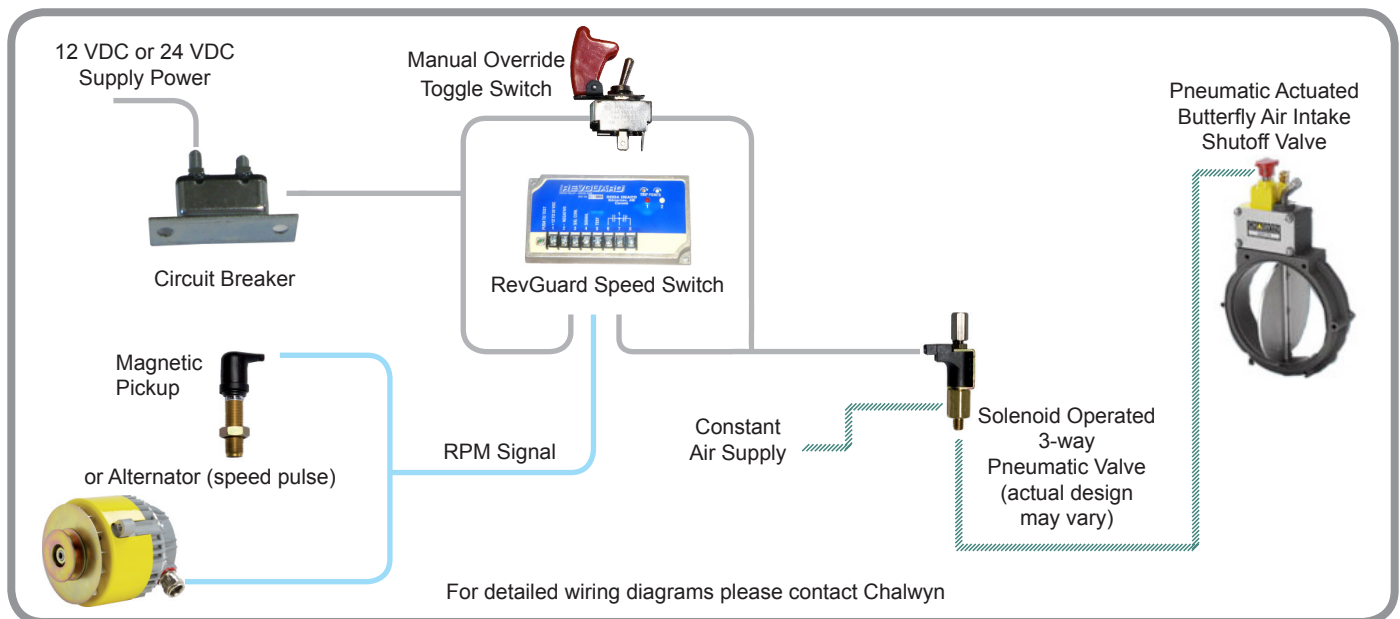

Butterfly Air Intake Shutoff Valve

Used to seal off intake air to a diesel engine for safe emergency shutdown

- Sizes range from 1.1/2" to 8" diameter
- Pneumatic trip/manual reset version
- Optional position sensor switch
- Pneumatic close/automatic reset version
- Temperatures from -40°F to 300°F (-40°C to 150°C)

Solenoid Operated Pneumatic Valve

Uses the trip signal to actuate the air pressure to close the Air Intake Shutoff Valve

- 12 or 24 VDC
- Normally open contacts
- Simple On/Off Circuit without needing a relay
- Opens air flow when energised
- Closes when engine speed falls
- Automatically vents to allow reset of shutoff valve
- Controlled slow venting option

RevGuard Speed Switch

Monitors engine RPM to shut down a runaway engine at a preset limit

- Accepts either low or high frequency input
- Operates on 12 or 24 VDC systems
- LED trip indicator
- Built-in 2/3 of RPM test button to simulate overspeed
- Compact design for behind dash mounting

Manual Override Toggle Switch

Enables an operator to manually close the air intake shutoff valve

- Military switch includes safety thumb guard
- Silver contacts for durability
- Chalwyn decal included (North American market)

Manual Engine Overspeed Shutdown Systems

Manual Electric Overspeed Shutdown System

The manual electric overspeed protection shutdown system uses a Manual Toggle Switch to trigger a manual closure of the Air Intake Shutoff Valve.

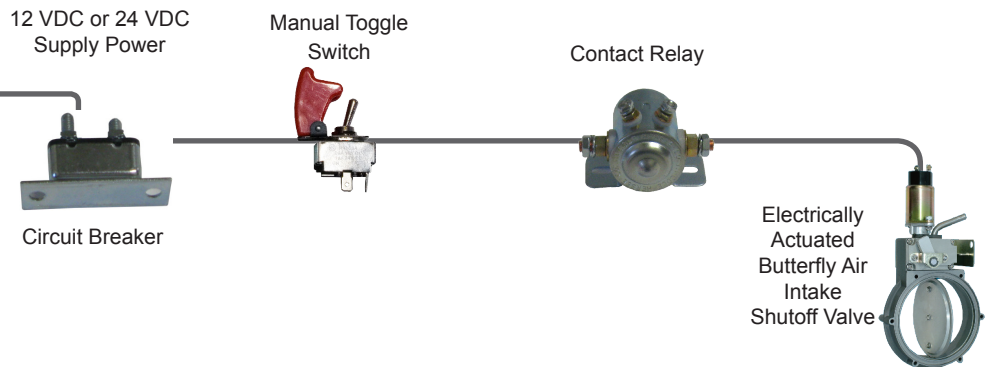

Manual Electric to Pneumatic Shutdown System

The manual electric to pneumatic shutdown system uses the Manual Toggle Switch to activate the 3-way Pneumatic Solenoid which pressurizes the Air Intake Shutoff Valve to close.

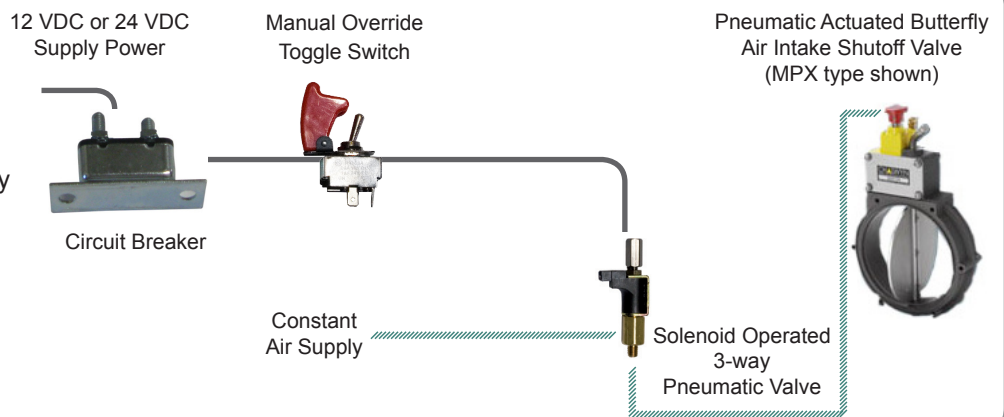

Butterfly Intake Shutoff Valve

Used to seal off intake air to a diesel engine for emergency shutdown

- Sizes range from 1 1/2" to 8"
- Electric versions in 12 or 24 VDC with manual reset
- Temperatures from -40°F to +300°F (-40°C to 150°C)
- Position indicator switch available
- Pneumatic version (manual reset)
- Remote manual pull cable available
- Pneumatic version (automatic reset)

Contact Relay

Carries momentary high current to electric valve during operation

Manual Toggle Switch

Enables an operator to manually close the air intake shutoff valve

- Includes safety thumb guard
- Silver contacts for durability
- Chalwyn decal included (North American market)

Circuit Breaker

Protects system from over current

Cable Operated Shutdown System

The cable operated system uses a pull cable with T-handle to manually close the Air Intake Shutoff Valve.

Versions for twin remote pull cables available. Versions using remote push to stop button are also available.

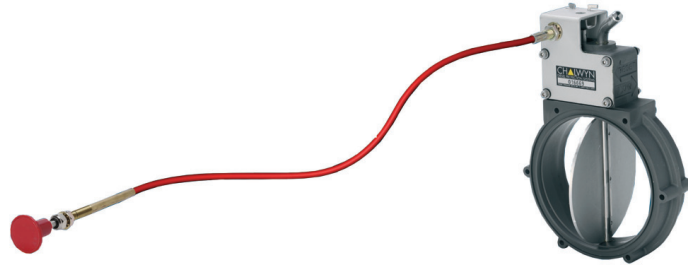

Pneumatic or Manual Cable Operated Shutdown System

The pneumatic manual shutdown system uses the pneumatic manual toggle valve to pressurize the Air Intake Shutoff Valve to close.

Secondary operation by a remote cable and either manual push or manual pull control is available on some models.

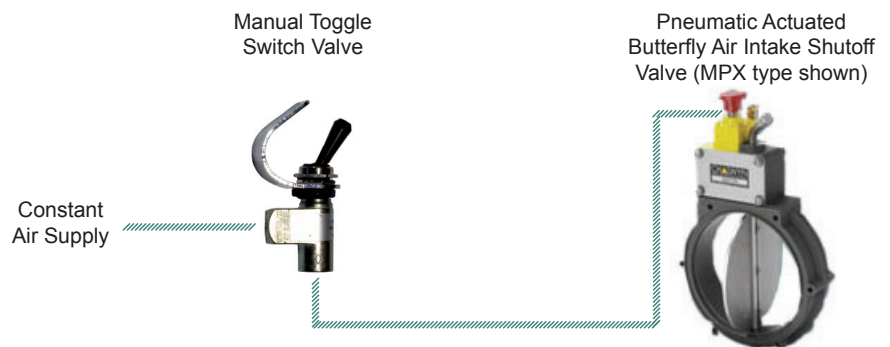

Pull Cable with T-Handle

Enables an operator to pull a red T-handle to manually close the Air Intake Shutoff Valve

- Stainless steel core for corrosion resistance
- Flexible construction allows small radius curves or bends without binding
- Available in lengths up to 40 ft (12.2 m)

Push Cable with Stop Button

Enables an operator to push a red stop button to manually close the Air Intake Shutoff Valve

- Stainless steel core for corrosion resistance
- Flexible construction allows small radius curves or bends without binding
- Available in lengths up to 40 ft (12.2 m)



PVX Type



SVX Type

Butterfly Air Intake Shutoff Valves

The Butterfly Air Intake Shutoff Valve provides emergency shutdown of a diesel engine. When the positive spring actuated valve closes, it starves the diesel engine of air and combustible vapor ingested through the air intake line.

- Compact design
- Three body sizes:
 - 3", 5", 8"
- Large range of modular hose adaptors between 1 1/2" and 8"
- Step change of diameter possible
- Electric SVX range in 12 or 24 VDC
- Manual reset by lever on valve
- Position indicator switch available
- Pneumatic MPX range (Manual reset)
- Pneumatic PVX range (Automatic reset)
- Manual MVX versions (Manual reset)
- Versions with combinations of features
- Designed for -40°C to 150°C (-40°F to 300°F) intake air
- Major components manufactured of aluminum, brass, and stainless steel
- Corrosion resistant body components
- Zinc body versions for Group 1 or mining available
- Manufactured in the United Kingdom

For specific dimensions, view technical brochures at www.dieselsafety.com/technical downloads

Overspeed Switches

Chalwyn offers two speed switches to complete the automatic safety system:



- **RevGuard Speed Switch**
 - Single and dual setpoint versions available (RGR-1S or RGR-2S)
 - Operates on 12 VDC or 24VDC systems
 - LED trip indicator
 - Built-in 2/3 of RPM test button to simulate overspeed condition
 - Easily installed using standard connectors
 - Optional lightweight Polymer enclosure available
 - Optional RGR-FP Filter Pack available for 2010 onwards Ford and Bosch alternators
- **CSX-300 Range Speed Switch**
 - Includes 50 AMP contact relay built in
 - Splash resistant IP66 metal enclosure
 - Optional sensor detection circuit
 - Simple push button speed setting
 - Factory set voltage and high/low speed inputs (specify when ordering)
 - Cable glands included
- **CSX-840 Remote Push Stop Button**
 - Compatible with CSX-300 range
 - System status LED indicator
 - Splash resistant Polymer casing

For systems that must operate in ATEX defined hazardous areas (Zone 2) please see "Shutdown Systems - Electric" at www.dieselsafety.com

Solenoid Operated Pneumatic Valves

When the system detects overspeed and applies battery voltage to the 3/2 way valve, the solenoid opens the internal ports allowing air pressure to pass and trip the air intake valve. When the engine speed drops, the system disconnects the power so that the valve vents the line to the air intake valve and closes (resets) automatically.

- Ideal for large trucks with air braking systems
- 12 V and 24 V models available
- Brass valve body
- 1/4" BSP threads for air fittings (see Pneumatic Installation Kit)
- SVA-200 type has DIN connection and cable plug included (rated IP65)
- Rated for pressurised air up to 10 bar (140 psi) and 90°C (190°F)
- Other models offered in North American markets



SVA-200
(24 VDC)

Pneumatic Installation Kit

Chalwyn can supply SKA-100 Kit for simple installation of PVX & MPX valves to SVA-200. This includes 6 mm hose, 1/8" & 1/4" BSP fittings, various straight and tee connectors and an adjustable air vent valve for correct operation of automatic reset systems using PVX-301/501 intake shutoff valves.

Actuation Kits (North American market only)

Actuation kits are available to make the system installation easier. The actuation kit contains hardware required to properly install and integrate the specified shutdown system into the diesel engine application. The kits, specific for each type of system and application, can include items such as:

- Contact relay with base and terminals
- Circuit breaker
- Toggle switch or valve
- 3-Way pneumatic solenoid
- Pneumatic hose and fittings

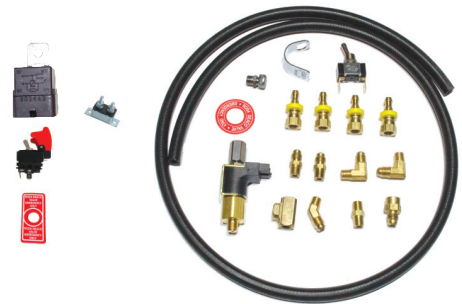

Kit Numbers (North American market only)

- AK-E1-RM-CH Actuation Kit, Electric 12 V with relay, manual switch and circuit breaker
- AK-E2-RM-CH Actuation Kit, Electric 24V with relay, manual switch and circuit breaker
- AK-PO-V-CH Actuation Kit, Pneumatic manual with toggle air valve, connectors and hose
- AK-P1-M-CH Electric to Pneumatic Actuation Kit 12V with standard automotive air valve and other items
- AK-P1-SM-CH Electric to Pneumatic Actuation Kit 12 V with heavy duty air valve and other items
- AK-P2-SM-CH Electric to Pneumatic Actuation Kit 24V with heavy duty air valve and other items

Automatic Electric System Wiring Diagram

Wiring diagram for 24 Volt Chalwyn SVX valve with speed signal from alternator

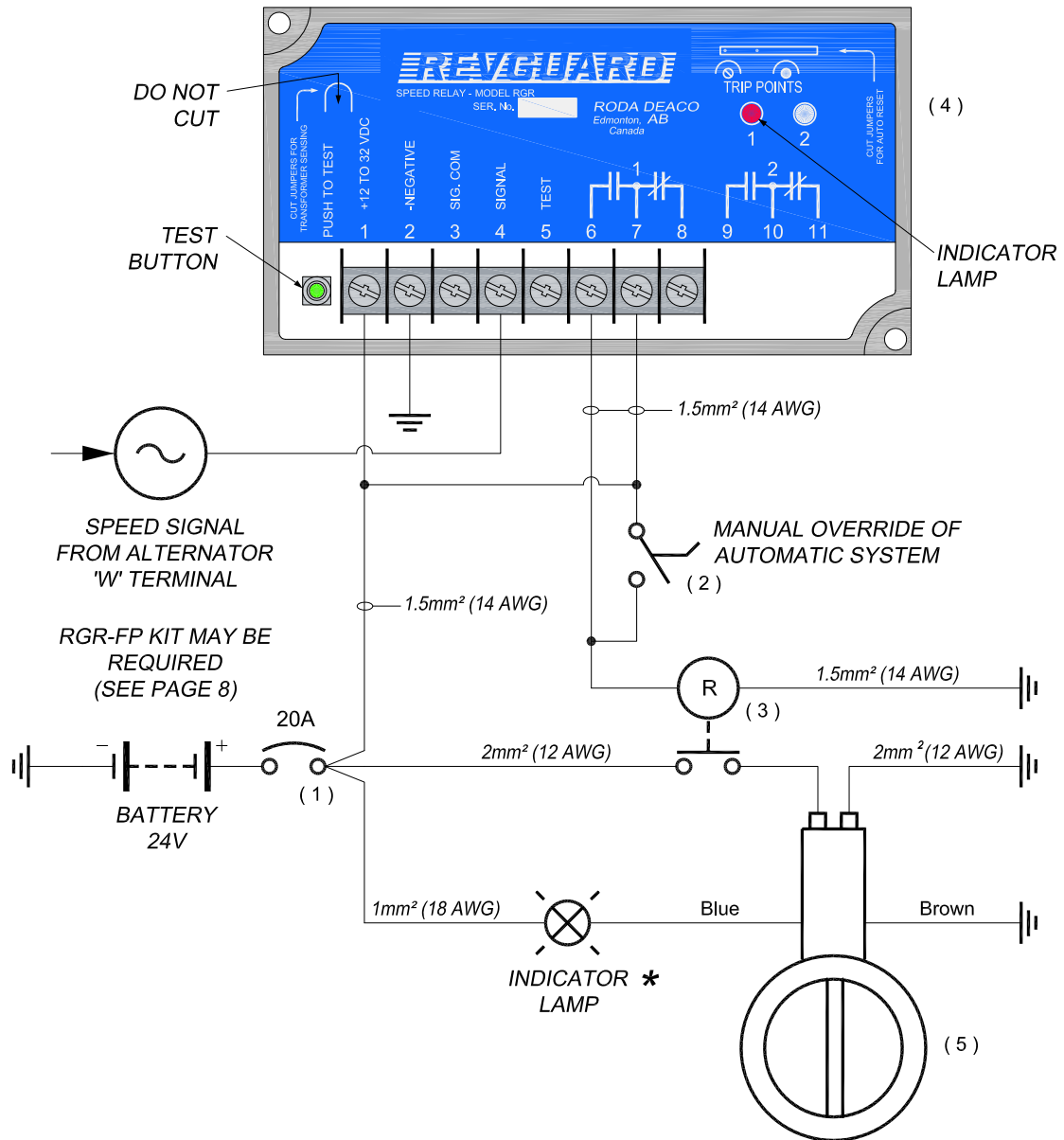

ITEM ()	PART No.	DESCRIPTION
1	30172-20	CIRCUIT BREAKER 20A
2	4004-018	TOGGLE SWITCH
3	1641-24V	RELAY (24V)
4	RGR-1S	SPEED SWITCH
5	SVX-3/5/890	CHALWYN VALVE

* THIS INDICATION CIRCUIT ONLY APPLIES TO SVX MODELS WITH MICRO-SWITCH (NOT SVX-**1 MODELS)

CHECK SYSTEM REGULARLY TO ENSURE THAT IT IS FUNCTIONING CORRECTLY

Automatic Electric to Pneumatic System Wiring Diagram

Wiring diagram for 12 Volt Chalwyn MPX valve with electric/air solenoid and magnetic pick-up signal

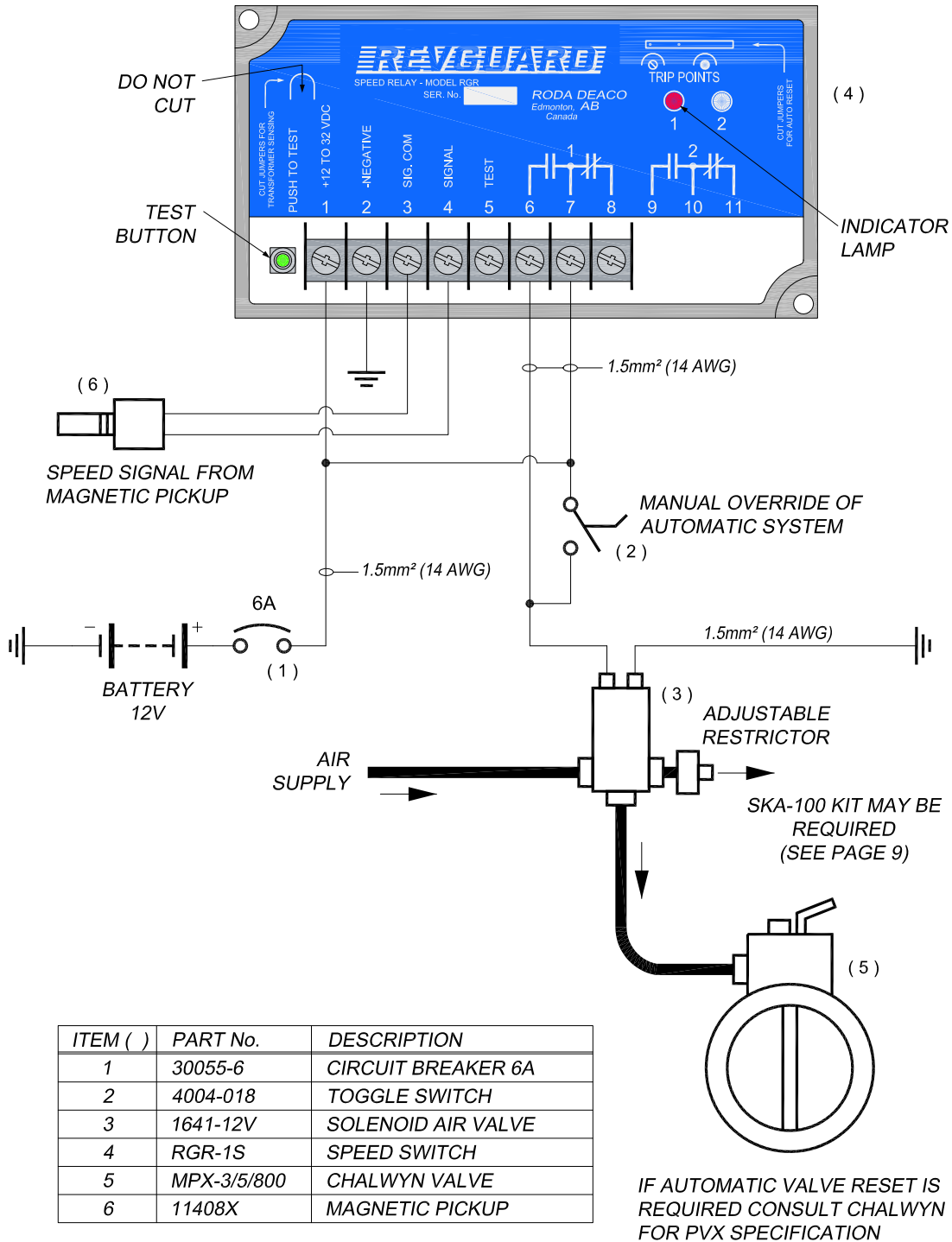

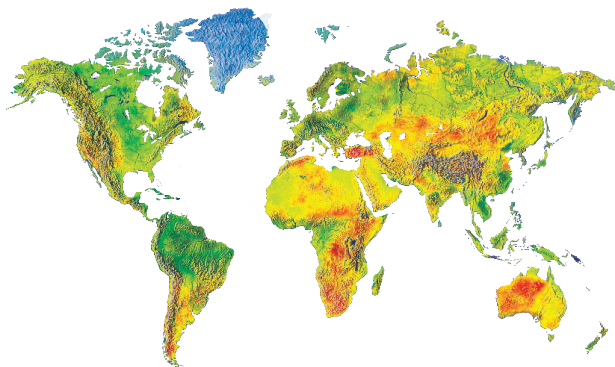

Chalwyn has a history of almost 40 years in manufacturing engine safety shut down valves to support the oil and gas industry.

In 2008 Chalwyn was acquired by AMOT, a global manufacturer of valves, controls and monitoring solutions for the protection of engines, compressors, turbines and heavy equipment. AMOT has served a wide variety of markets since 1948 including industrial, marine, oil and gas, power generation and transportation.

Together, the AMOT, Roda Deaco and Chalwyn brands offer an extensive family of engine safety solutions that are approved by many significant oil, gas and LNG production companies and their major contractors.

To find your nearest supplier for Diesel Engine Safety Solutions, please visit the home page of our website, www.dieselsafety.com and select 'distributors'.

Contact us

NORTH AND SOUTH AMERICA

8824 Fallbrook Drive
Houston, Texas 77064, USA
tel: +1 281 940 1800
fax: +1 713 559 9419

NORTH AND SOUTH AMERICA

3230 97 Street
Edmonton, Alberta, T6N 1K4, Canada
tel: +1 780 465 4429
fax: +1 780 469 6275

EUROPE, MIDDLE EAST AND AFRICA

Western Way, Bury St. Edmunds
Suffolk, IP33 3SZ, United Kingdom
tel: +44 (0)1284 715739
fax: +44 (0)1284 715747

ASIA PACIFIC

Rm A308 Building A8, Jiahua Business Ctr
808 Hongqiao Road, Shanghai 200030, China
tel: +86 (0) 21 6447 9708
fax: +86 (0) 21 6447 9718

www.dieselsafety.com

CHALWYN
by AMOT

The contents of this publication are presented for informational purposes. While every effort has been made to ensure their accuracy, they are not to be construed as warranties or guarantees, express or implied, regarding the products or services described herein or their use or applicability. The purchaser and end user are responsible for analyzing all aspects of their application and using their own judgment in the final selection, use, and maintenance of the system and components. The purchaser and end user are also responsible for assuring that all performance, safety and warning requirements of the application are met. Chalwyn, AMOT, Roper Industries, or any of their affiliated entities assume no responsibility for the selection, use, or maintenance of any product.